

DESCRIPTION

Ryanfire SL Collars are designed to maintain the fire resistance of fire rated walls and floors. The SL collars consist of a high quality stainless steel case lined with a highly reactive graphite infused material.

Upon exposure to heat the SL collar will quickly and effectively close any openings that may form due to the melting away of services.

Ryanfire SL collars have a handy slim line profile providing a low clearance around services on which they are installed.

CERTIFICATION

Ryanfire SL Collars have been tested and assessed in accordance with AS1530.4:2014 and AS4072.1:2005 at IANZ/NATA accredited laboratories, and environmentally tested to ASTM-B117 for semi-external use.

APPLICATION

Ryanfire SL Collars have been tested in various types of walls and floors including plasterboard, masonry, concrete, composite floors, Timber Infill, Korok, PLT and plasterboard ceilings.

The SL collars are suitable to protect a wide range of services :

HVAC bundles	Cables	Insulated metal pipes
uPVC	PE-RT	Polybutylene
HDPE	MDPE	PPR
PEX	PEX-AL	uPVC sockets

The SL collars may be installed in semi-external conditions following our recommended maintenance procedures.

PRODUCT DIMENSIONS

Ryanfire SL Collars have been designed to fit most common services and come in the following sizes:

Code	SL 25	SL 32	SL 40	SL 55	SL 65	SL 82	SL 110	SL 125	SL 160
Collar Inside Ø mm	25	34	43	57	68	84	115	126	165
Collar Outside Ø mm	35	48	57	71	82	98	134	145	198
Collar Height mm	30	30	30	30	30	45	45	45	45
Fixing Lugs	2	2	2	2	2	3	3	3	3

NOTE: Sizes and dimensions are nominal.



Ryanfire SL110

Ryanfire SL Collars are usually used in conjunction with other Ryanfire products. Please contact the technical department for specific and more detailed "V" drawings.

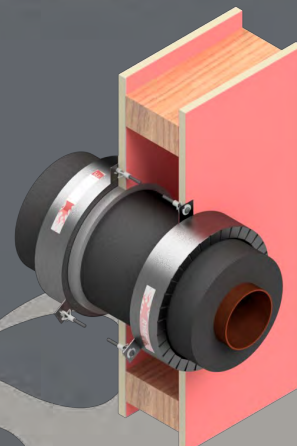
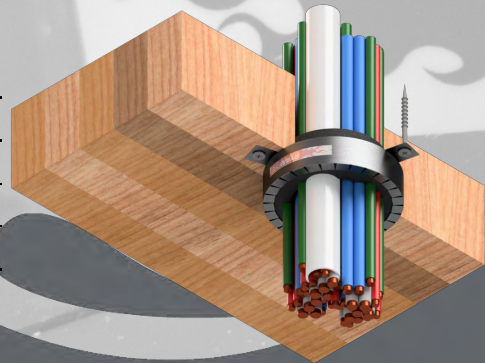
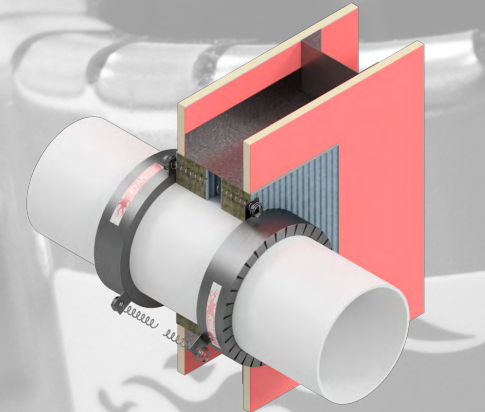

FEATURES

- Tested to AS1530.4:2014
- Low profile slimline design
- Stainless steel
- Retro fit capable
- Up to 120mins FRR

The information provided in this document is issued in good faith. As part of Ryanfire Products Ltd ongoing product development and testing, we reserve the right to modify product specifications without notice. Any drawings given are for illustrative purposes only. Ryanfire Products Ltd accepts no liability whatsoever for any loss, damage or injury arising from the misinterpretation or misuse of the information given. Subject to our standard terms and conditions.



For more information please contact Ryanfire
info@ryanfire.co.nz 09 443 0362