



**William Hackett**

# *L4 Lever Hoist User Manual*





# Contents

1.	Dimensions and Specifications .....	4
2.	Hoist Selection .....	5
3.	Pre-use checks .....	6
4.	Operation .....	7
5.	Safe Use Information .....	8
6.	Storage and Control Procedures .....	9
7.	Practical Considerations .....	10
8.	Spare Parts Inspection Category .....	11
9.	Parts List .....	12
10.	Parts Explosion .....	13
11.	Hoist Disassembly .....	14-15
12.	Maintenance and Repair .....	16-25
13.	Assembly Instructions .....	26-27
14.	Miscellaneous .....	28
15.	Warranty .....	29

## APPENDIX

Fleeting Guidance	31-38
-------------------	-------

# Dimensions and Specifications

## Single Fall

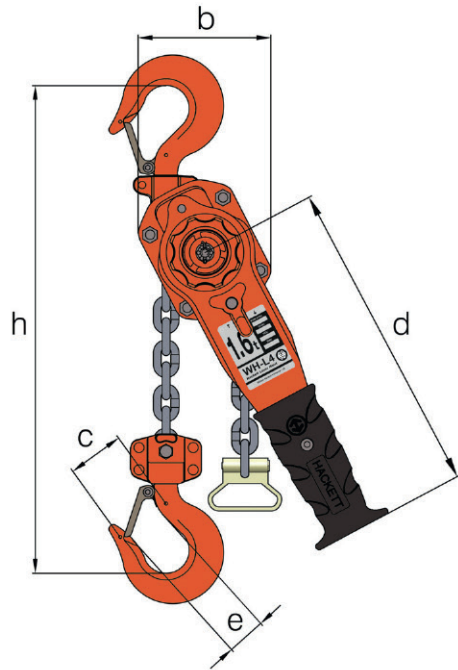

## Multi Fall

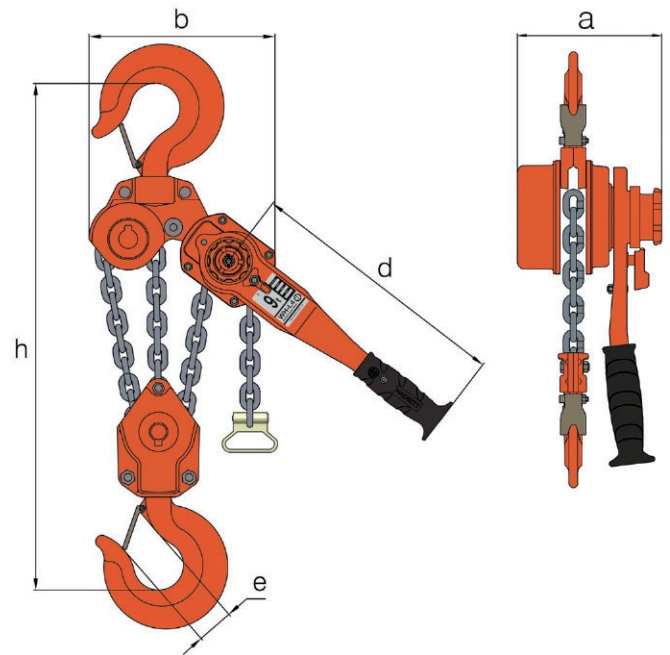

**Table 1: Product specification, dimensions and WLL for William Hackett L4 Lever Hoists**

Part Code	WLL tonnes	No. of Falls	Load Chain mm	Std. Lift (m)	a mm	b mm	c mm	d mm	e mm	h mm	Mass kg	Extra Weight per M kg
033.080	0.8	1	5.6 x 17	1.5	148.0	121	41.5	265	28	280	6.20	0.68
033.160	1.6	1	7.1 x 21	1.5	165.5	141	52.0	415	33	350	9.60	1.08
033.320	3.2	1	10 x 30	1.5	194.5	178	61.9	415	42.5	420	15.50	2.17
033.630	6.3	2	10 x 30	1.5	194.5	228	84.3	415	51	570	27.00	4.34
033.900	9.0	3	10 x 30	1.5	194.5	310	86.0	415	56	680	38.30	6.51
033/1500	15.0	6	10 x 30	1.5	194.5	420	-	415	80	1000	90.00	13.02
033/2000	20.0	8	10 x 30	1.5	194.5	480	-	415	80	1150	195.00	19.20

## Hoist Selection

In accordance with statutory requirements (e.g. The Lifting Operations and Lifting Equipment Regulations 1998), all lifts using lever hoists should be planned by a competent person; require risk assessment and the production of a task method statement; and be subject to execution by suitably trained operatives under the supervision of a responsible person. The specification of the lever hoist required to achieve a safe lifting operation must be determined by a competent person.

It is not intended that the recommendations in this manual take precedence over existing plant safety rules and regulations or OSHA regulations. In the event that conflict exists between a rule set forth in this publication and a similar rule already set by an individual company, the more stringent of the two should take precedence.

Careful consideration should be given to the mass of the load being lifted and any dynamic factors that may be likely to affect the load on the hoist. Select the hoist capacity equal to or greater than the load. Ideally lever hoists should not be used to lift loads below 10% of their rated WLL limit.

William Hackett L4 lever hoists are assembled, chained and tested in the UK to the height of lift specified by the end user. Careful consideration should be given to the headroom required to lift the load and the position of the operator before specifying the length of load chain and the hoist model.

The configuration of lever hoist assemblies are demonstrated on page 4, and are in accordance with the product specification, dimensions and working load limit (WLL) recorded in Table 1 (also on page 4).

William Hackett L4 lever hoists are designed for industrial applications in both indoor and outdoor plus topside marine environments.

William Hackett lever hoists are available in specialised versions to suit hazardous environments. The L4 Atex hoist is suitable for spark sensitive use and the SS-L5 QP is corrosion resistant and suitable for subsea use.

William Hackett L4 lever hoists can be used within an operating temperature range of -20°C to +120°C.

William Hackett L4 hoists are suitable for fleeting lifting. If multiple hoists are to be used in a fleeting operation, refer to Appendix 1: General Guidance for Fleeting Lifting at the end of this manual.

A thorough study of the information in this manual should provide a better understanding of safe operating procedures and afford a greater margin of safety for people and equipment.

## Pre-use checks

Before the lever hoist is issued from the designated storage location a competent person must ensure that the appropriate certification is in place for the hoist.

Safe use instructions should be made available.

Possession of the relevant certification does not absolve the user from his responsibility to carry out pre-use inspections.

Conducting thorough and consistent checks on a lever hoist immediately prior to use will help identify problems due to accidental damage, internal corrosion, brake contamination or inappropriate storage.

Points to check before each period of use are:

- If necessary, the hoist should be cleaned before inspection.
- Name Plate – details clear and visible
- Hook latches in good working order
- Is the Load chain worn or damaged. In particular attention should be given to the wear which occurs on the bearing surfaces inside the links and to damage in the form of bent, notched, stretched, or excessively corroded links and the chain should move freely.
- Obvious signs of hooks opening out increase in throat opening or any other form of distortion in the hooks or suspension fittings.
- Top and bottom hooks free to rotate with no load applied.
- With no load applied turning the grip ring clockwise should produce a clear and positive clicking sound as the brake ratchet activates.
- On multiple fall hoists check that all chain sheaves are free to rotate whilst no load is applied.
- Check all fixings are in place and in good condition, split pins or nyloc nuts.
- Obvious signs of damage to the hoist slack end chain anchor.
- General damage to the hoist body, this can be an indicator of neglect throughout the hoist.
- The load chain wheel should be checked for damage or debris
- Chain guides and strippers should be free of debris and in good condition.

These checks should be performed with the hoist unloaded.

- Lifting function - select 'UP' and whilst pulling the load side of the chain, operate the lever handle clockwise, the ratchet brake mechanism shall engage operate smoothly without snagging.
- Lowering function - Select 'DN' and with a light pull of the load side chain, operate the lever counter clockwise, no clicking shall be audible and the chain should pay out smoothly.
- Neutral or free chaining - with the selector lever in the 'N' position, the chain shall adjust freely via the hand wheel or by pulling of the load chain.

**If any of these points are not satisfied the hoist MUST NOT be used.**

# Operation

## Free Chain Adjustment

1. To adjust the chain, position the selector lever in the horizontal neutral position (N).
2.
  - a) In Neutral mode the load chain can be pulled to adjust to the required length, this can be aided by turning the handwheel in the relevant direction – see 2b.
  - b) Alternatively, the Chain can be adjusted by turning the handwheel clockwise to raise/shorten or counter clockwise to lower/lengthen the load side chain.

Advice: Sharp pulling of the load chain can cause the brake to activate, pull the chain progressively and smoothly.

## Lifting and Lowering

1. For lifting, position the selector lever in the UP position and operate the lever clockwise.
2. For lowering, position the selector lever in the DN position and operate the lever counter clockwise.

Note: when holding a load it is recommended to position the selector lever in the 'UP' position.

## Safe Use information

Do not attempt lifting operations unless you understand the use of the equipment, the lifting and slinging procedures and you have been suitably trained.

William Hackett L4 lever hoists are not designed for lifting people and should not be used for that purpose.

Use appropriate personal protective equipment (PPE).

Check the correct engagement of the top and bottom hooks. The hooks should be free to articulate within the load attachment points without overcrowding.

Do not use the handwheel whilst the hoist is loaded.

When the hoist is under load ensure that the selector lever is in the UP position.

Whilst loaded do not try to make chain adjustments by pulling the load chain.

Ensure that the work area is clear to avoid the slack end chain snagging in use.

Ensure that the suspension structure has sufficient load bearing strength and capacity to support the load.

Do not use the lever hoist as a chain sling; it is a lifting appliance and suitable lifting accessories should be incorporated into the lift plan to facilitate a safe lifting operation.

If more than one lever hoist is to be used, refer to Appendix 1: General Guidance for Fleeting Lifting at the end of this manual.

Establish a clearly defined zone around the area of the lifting operation.

Always stand aside from the load when operating the hoist and ensure that no one enters the lift zone unintentionally during the lifting operation.

Ensure that the load chain is not twisted, particular care should be taken when using multi-fall hoists.

During the lift the load chain should be straight and should not contact any angles or edges.

Take the load steadily and avoid shock loads.

Do not expose lever hoist assemblies, chain slings and components to chemicals or corrosive solutions (whether immersed in such solutions or used in atmospheres in which fumes are present), particularly acidic or strongly alkaline environments without consulting the supplier or manufacturer.

Do not leave suspended loads unattended. In an emergency cordon off the working area and establish safe exclusion zones.

Never return a damaged lever hoist to stores; it should be reported to a competent person.



## **Storage and Control Procedures**

The equipment should ideally be stored in a purpose designed facility where it can be kept secure from unauthorised use. A responsible person should control the issue and receipt of all lifting appliances and accessories, and a system to manage statutory inspections should be in place.

Storage would normally be on suitable racks within a container a manner that prevents accidental mechanical damage and where the load chains are clear from the ground.

The load chain should be dried and wrapped around the hoist, not left on the floor

During transport to the worksite and whilst in store at the worksite, the equipment should be protected from exposure to any conditions which may affect its ability to operate safely. In particular, it should be protected from exposure to:

- water/sea water;
- temperatures higher than can be comfortably tolerated by the hand
- temperatures below freezing point
- solvents
- corrosive chemicals or fumes
- grit, sand and wind-blown dust.

Any defects should be reported to the responsible person and damaged hoists should be quarantined.

Duty holders and actual users of lifting equipment, including hoists and associated components can obtain more detailed information and guidance on safe use and compliance with statutory requirements from the following publications;

HSE Publication L22 (2014) Safe Use of Work Equipment.

HSE Publication L113 (2014) Safe Use of Lifting Equipment.

HSE Publication INDG422 (2008) Thorough Examination of Lifting Equipment.

HSE Publication L23 (2004) Manual Handling.

HSE Publication L25 (2005) Personal Protective Equipment at Work.

## **Practical Considerations**

As with any item of lifting equipment, the lever hoist will be specified for a maximum working load limit. This should not be exceeded during any lifting operation. It is important, therefore, when planning a lifting operation that the load to be lifted by the lever hoist is known or has been accurately estimated with an adequate allowance for safety. The possible effects of additional loading, such as friction, should be included when the lever hoist is being selected for the lift.

The design of lever hoists is such that a brake mechanism is used to suspend the load, but also requires a load to operate. When planning a lifting operation using a lever hoist or selecting a lever hoist for a lift, the light load limitation of the braking mechanism should be recognised. The William Hackett WH-L4 lever hoist is tested and certified to have a light load capability at 2% of the lever hoist rated capacity, but it is not recommended to use a lever hoist at below 10% of the rated capacity, but it is not recommended to use a lever hoist at below 10% of the rated capacity.

A lever hoist should be loaded and unloaded using the lever handle. When a load is removed from a lever hoist other than by the use of the lever handle (e.g. by transfer of a load to a surface crane) the brake mechanism will remain locked together. Subsequent loading of the hoist (for example, by the transferring of a load on to the hoist from a surface crane) will result in the load being applied to a locked brake mechanism - something manufacturers regard as bad practice, potentially resulting in unexpected slippage as the hoist is then operated. If a load is removed from a lever hoist, the lever handle should be operated to unlock the brake and confirm the hoist is fully functional before the lever hoist is used for another lifting operation.

## Spare Parts Inspection Category

STANDARD INSPECTION - Type 2			Standard Corrosion Protected or Painted Components
Part Code	Quantity	Description	Inspection Type (1 or 2)
			L4
L4.01	1	Left Side Plate Assembly	2
L4.02	1	Load Sheave	2
L4.03	2	Chain Guide	2
L4.04	1	Top Hook Pin	2
L4.05	1	Top Hook Assembly	2
L4.06	1	Right Side Plate Assembly	2
L4.07	1	Load Gear	2
L4.08	1	Pinion Shaft	2
L4.08A	1	Pinion Shaft Washer	2
L4.09	2	Pinion Gear (pair)	2
L4.10	1	Gear Cover	2
L4.11	8	Nut	2
L4.12	1	Chain Stripper	2
L4.13	1	Disc Hub	2
L4.14	2	Pawl Spring	2
L4.15	2	Pawl	2
L4.15A	1	Circlip	2
L4.17	2	Friction Disc (pair)	2
L4.18	1	Ratchet Gear	2
L4.20	2	Spring	2
L4.21	2	Lock Nut	2
L4.22	1	Handle Cover Assembly	2
L4.23	1	Change Gear	2
L4.24	2	Change Over Pawl	2
L4.25	1	Change Over Spring	2
L4.26	1	Change Over Stand	2
L4.28	1	Lever Handle Assembly	2
L4.29	1	Screw	2
L4.29A	1	Spring Washer	2
L4.30	1	Grip Ring	2
L4.31	1	Stop Cam	2
L4.32	1	Washer	2
L4.33	1	Castle Nut	2
L4.34	1	Split Pin	2
L4.36	1	Square Type End Stop	2
L4.37	1	Bottom Hook Assembly	2
L4.38	1	Chain Fixing Pin	2
L4.47	1	Latch Kit	2
L4.48	1	Label	2
L4.49	4	Label Rivets	2

# Parts List

Part Code	Part Name	L4 Finish
L4.01	Left Side Plate Assembly	Zinc
L4.02	Load Sheave	Black
L4.03	Chain Guide	Zinc
L4.04	Top Hook Pin	Black
L4.05	Top Hook Assembly	Zinc - Powder Coated
L4.06	Right Side Plate Assembly	Powder Coated
L4.07	Load Gear	Black
L4.08	Pinion Shaft	Black
L4.08A	Pinion Shaft Washer	Zinc
L4.09	Pinion Gear (pair)	Black
L4.10	Gear Cover	Powder Coated
L4.11	Nut	Zinc
L4.12	Chain Stripper	Zinc
L4.13	Disc Hub	Zinc Flake
L4.14	Pawl Spring	Zinc
L4.15	Pawl	Zinc
L4.15A	Circlip	Zinc
L4.17	Friction Disc (pair)	N/A
L4.18	Ratchet Gear	Zinc
L4.20	Spring	Zinc
L4.21	Lock Nut	Zinc
L4.22	Handle Cover Assembly	Powder Coated
L4.23	Change Gear	Zinc Flake
L4.24	Change Over Pawl	Zinc
L4.25	Change Over Spring	Zinc
L4.26	Change Over Stand	Zinc
L4.28	Lever Handle Assembly	Powder Coated
L4.29	Screw	Zinc
L4.29A	Spring Washer	Zinc
L4.30	Grip Ring	Powder Coated
L4.31	Stop Cam	Zinc Flake
L4.32	Washer	Zinc
L4.33	Castle Nut	Zinc
L4.34	Split Pin	Zinc
L4.36	Square Type End Stop	Zinc
L4.37	Bottom Hook Assembly	Zinc - Powder Coated
L4.38	Chain Fixing Pin	Black
L4.47	Latch Kit	Zinc
L4.48	Label	N/A
L4.49	Label Rivets	N/A

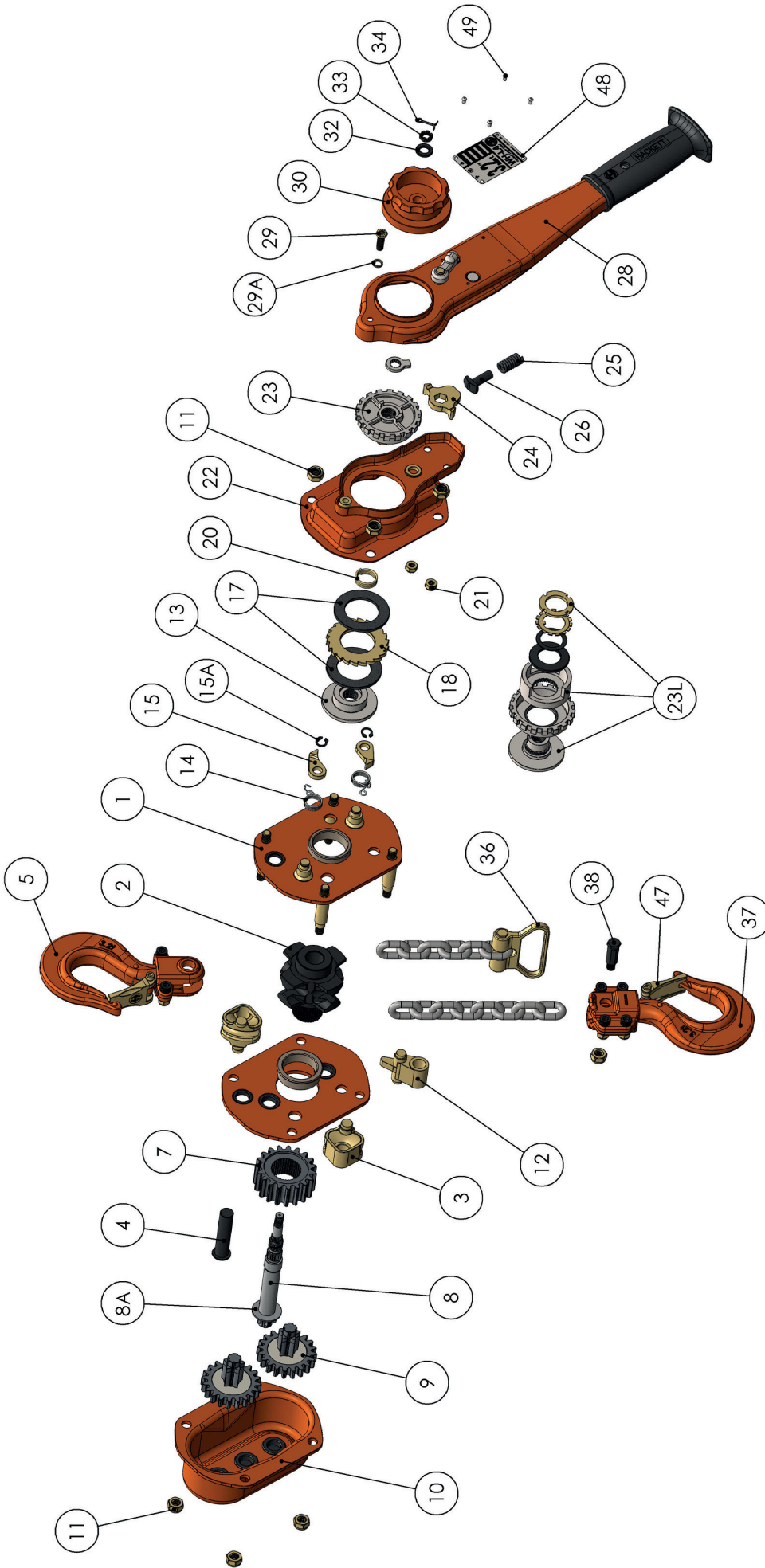

Part Code	Part Name
L4.01	Left Side Plate Assembly
L4.02	Load Sheave
L4.03	Chain Guide
L4.04	Top Hook Shaft
L4.05	Top Hook Assembly
L4.06	Right Side Plate Assembly
L4.07	Load Gear
L4.08	Pinion Shaft
L4.08a	Pinion Shaft Washer
L4.09	Pinion Gear (pair)
L4.10	Gear Cover

Part Code	Part Name
L4.11	Nut
L4.12	Chain Stripper
L4.13	Disc Hub
L4.14	Pawl Spring
L4.15	Pawl
L4.15a	Circclip
L4.17	Friction Disc (pair)
L4.18	Ratchet Gear
L4.20	Spring
L4.21	Lock Nut

Part Code	Part Name
L4.22	Handle Cover Assembly
L4.23	Change Gear
L4.23L	Overload Limiter
L4.24	Change Over Pawl
L4.25	Change Over Spring
L4.26	Change Over Stand
L4.28	Lever Handle Assembly
L4.29	Screw
L4.29A	Spring Washer
L4.30	Grip Ring

Part Code	Part Name
L4.31	Stop Cam
L4.32	Washer
L4.33	Castle Nut
L4.34	Split Pin
L4.36	Square Type End Stop
L4.37	Bottom Hook Assembly
L4.38	Chain Fixing Pin
L4.47	Latch Kit
L4.48	Label
L4.49	Label Rivets

# Hoist Disassembly

## L4 Servicing Tool Requirements

Nylon/dead blow hammer	Sandpaper 120-240 grit
Ball Pein hammer	Circlip pliers
Phillips screw driver	Long nose pliers
Allen keys: 3mm, 4mm, 6mm and 8mm	Vernier Caliper
Phillips screwdriver	General purpose grease
Solvent free brake cleaner	Solvent free degreasing facility
Socket/wrench: 5mm, 7mm, 8mm, 10mm, 12mm, 13mm, 14mm and 17mm.	

The following procedures should only be performed by a competent person.

It is a responsibility of the owner/user to install, operate, inspect and maintain product in accordance with all applicable Standards and Regulations. If the product is installed as part of a lifting system, it is also the responsibility of the owner/user to comply with the applicable standards that address other types of equipment used.

## Hoist Disassembly

NEVER perform maintenance whilst the hoist is under load. Always use OEM parts where replacement parts where replacement parts are necessary.

These instructions should be used alongside the illustrated parts list.

It is recommended to keep the parts in order when disassembling to aid with assembly.

1. Remove and disassemble the bottom hook #37, check all parts especially the load pin #38 for excessive wear.
2. Remove the chain end stop #36.
3. Remove the load chain.
4. Remove split pin #34 discard and replace.
5. Remove castle nut and washer #32 and #33.
6. The grip ring #30 can now be lifted from the pinion shaft #8.
7. Remove handle fixings and washer #21, #29A and #29, the handle #28 can now be lifted from the remaining handle assembly #22 taking care with parts #24, #25 and #26.
8. Remove stop cam #31.
9. Remove change gear #23 by turning anti clockwise along with spring #20.
10. Remove 4 pcs of nylon locking nuts #11 from handle cover assembly and lift assembly from hoist body.
11. Remove the friction discs, ratchet gear and disc hub #13, #17 and #18.
12. Remove circlip #15A along with pawl and pawl springs #14 and #15.
13. On 1.5t/1.6t to 9t models the top hook pin and hook can now be removed.
14. Turn the hoist over and remove the 4 nylon locking nuts securing the gear cover along with gear cover, it is recommended to make a note of the position of the gear alignment marks at this point.
15. Remove the pinion gears #9 2 pcs and pinion shaft #8.
16. On 750kg/800kg models the top hook load pin and hook can now be removed.

17. The load gear #7 can now be lifted from the load sprocket/sheave.
  18. Remove top hook load pin #4.
  19. Gear side plate #6 can now be lifted from the main body.
  20. Remove parts #3 (2 pcs) and 12 making a note of their position on part #1 the wheel side plate.
  21. The load sheave can now be removed.
  22. Bearings can now be removed and serviced, plain bushes are a press fit part and not to be removed, disassembly complete.\*
    - Thoroughly clean all parts checking for damage, wear or foreign particles, if using a degreaser ensure all parts are dried and lubricated where necessary prior to assembly.
    - Please note split pins nylon locking nuts are classed as single use items.
    - It is also good practice to check the condition of circlip retainers and replace where necessary.
- \*Depending on model and capacity the hoist side plates may be fitted with a plain bush or bearing, this must be stated when ordering spares.

# Maintenance and Repair

## L4.01 Left Side Plate Assembly

Inspection Type: Visual

Quantity: 1

Examine body plates for alignment and ensure they are free from wear and distortion, examine load pin, guide and stripper holes for signs of wear and stretch, check stay bolts and pawl stands are secure and free from defects.

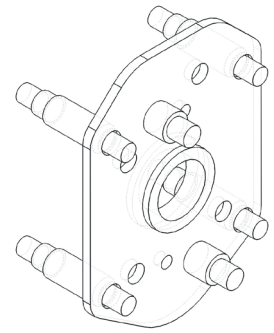

**Action: Shotblast and repaint or replace if necessary**

---

## L4.02 Load Sheave

Inspection Type: Visual

Quantity: 1

Check load chain pockets for wear and damage, ensuring satisfactory seating of load chain in pockets.

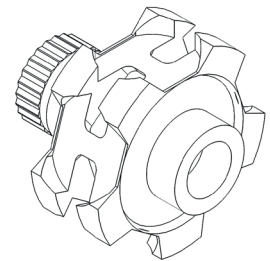

**Action: Clean, reapply grease or replace if necessary.**

---

## L4.03 Chain Guide

Inspection Type: Visual

Quantity: 2

Examine chain guide for wear, fracture and alignment.

**Action: Shotblast and repaint or replace if necessary.**

**For ATEX variant contact manufacturer.**

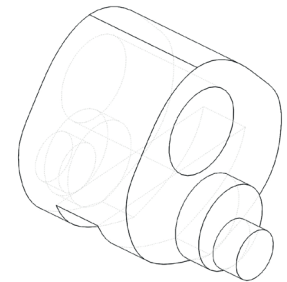

## L4.04 Top Hook Pin

Inspection Type: Visual and Dimensional - contact manufacturer

Quantity: 1

Check dimensionally and visually for damage or wear.

**Action: Replace if necessary.**

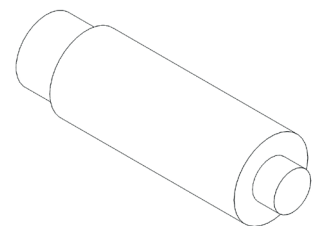



# Maintenance and Repair

## L4.05 Top Hook Assembly

Inspection Type: Visual and Dimensional - contact manufacturer

Quantity: 1

Check for distortion, damage, fractures and stretching. The hook shall be free and smooth to rotate, the hook to housing contact points should have even wear, check top hook bolt hole to diagram.

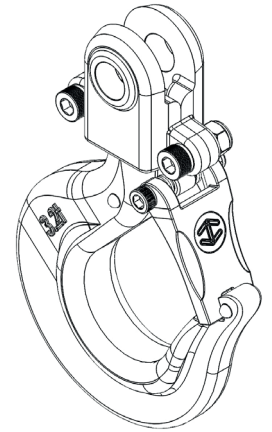

**Action: Shotblast and repaint or replace if required.**

**For ATEX variant contact manufacturer.**

## L4.06 Right Side Plate Assembly

Inspection Type: Visual

Quantity: 1

Examine gear side plates for alignment and ensure they are free from damage and distortion, examine load pin, guide, stripper and stay bolt holes for signs of wear and stretch, check gear bushings are secure and in good condition.

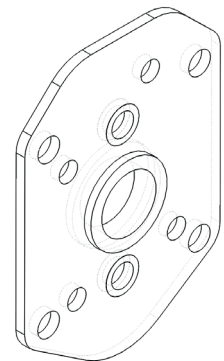

**Action: Shotblast and repaint or replace if necessary.**

## L4.07 Load Gear

Inspection Type: Visual

Quantity: 1

Examine gear for wear, fracture and alignment. Check condition of internal splines.

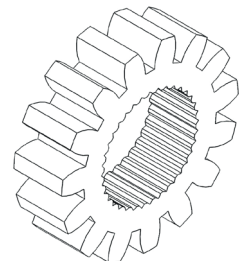

**Action: Clean, reapply grease or replace if necessary.**

## L4.08 Pinion Shaft

Inspection Type: Visual

Quantity: 1

Examine pinion shaft for damage and distortion, check shaft for straightness, spline and thread condition.

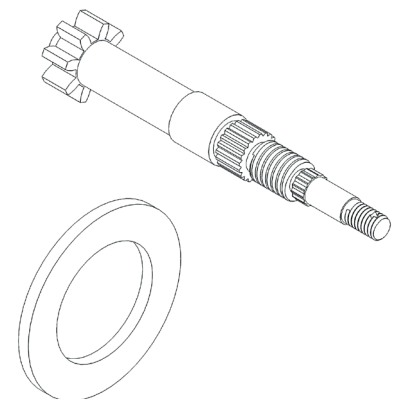

**Action: Clean, reapply grease or replace if necessary.**

# Maintenance and Repair

## L4.09 Pinion Gear

Inspection Type: Visual

Quantity: 2

Examine gears for wear, fractures and alignment

**Action: Clean, reapply grease or replace if necessary.**

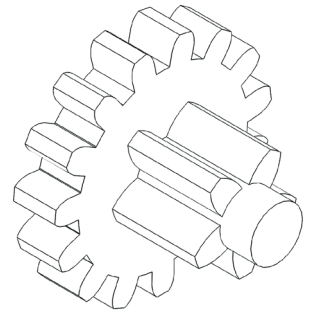

## L4.10 Gear Cover

Inspection Type: Visual

Quantity: 1

Examine for cracks, distortion, damaged or broken parts, check gear bushings are secure and in good condition.

**Action: Shotblast and repaint or replace if necessary.**

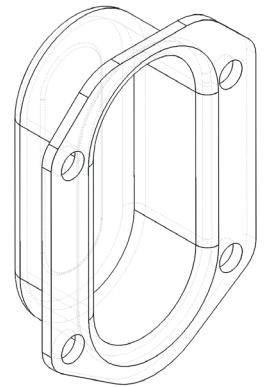

## L4.11 Nut

Inspection Type: Not Applicable

Quantity: 8

**Action: Discard and replace.**

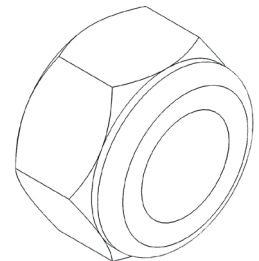

## L4.12 Chain Stripper

Inspection Type: Visual

Quantity: 1

Examine chain stripper for wear and damage.

**Action: Shotblast and repaint or replace if necessary.**

**For ATEX variant contact manufacturer.**

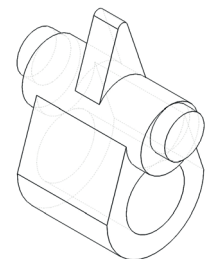

## Maintenance and Repair

### L4.13 Disc Hub

Inspection Type: Visual

Quantity: 1

Check splines and ensure the component mating surfaces are smooth, flat and without excessive corrosion.

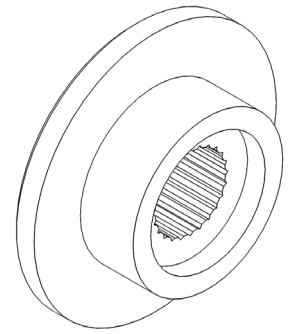

**Action: Replace if necessary.**

---

### L4.14 Pawl Spring

Inspection Type: Visual

Quantity: 2

Examine pawl springs for corrosion and fractures, ensure the spring is good working order and not deformed or stretched.

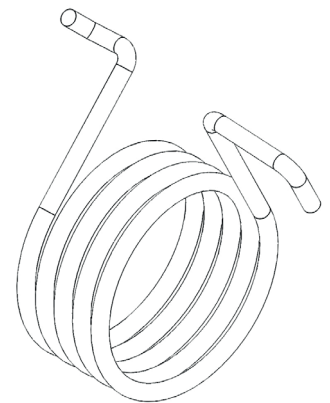

**Action: Replace if necessary.**

---

### L4.15 Pawl

Inspection Type: Visual and dimensional (see page 28)

Quantity: 2

Check pawl for wear ensuring pawl is free to move on pawl shaft

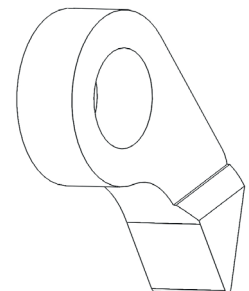

**Action: Replace if any defects found.**

---

### L4.15A Circlip

Inspection Type: Visual

Quantity: 1

Examine for cracks, distortion or damage

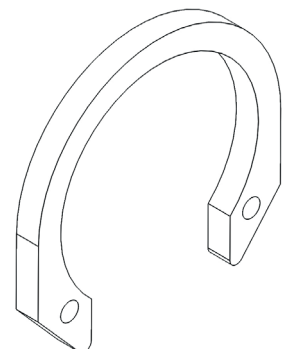

**Action: Replace if necessary.**

# Maintenance and Repair

## L4.17 Friction Disc

Inspection Type: Visual

Quantity: 2

Check for fractures, wear and damage ensuring mating surfaces are flat and clean and free from contaminants.

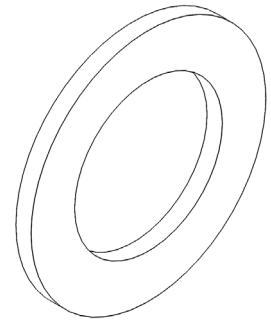

**Action: Replace if any defects found.**

---

## L4.18 Ratchet Gear

Inspection Type: Visual

Quantity: 1

Examine ratchet teeth and brake component surfaces ensuring they are smooth and flat.

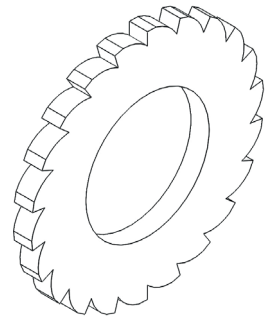

**Action: Replace if any defects found.**

---

## L4.20 Spring

Inspection Type: Visual

Quantity: 2

Examine spring for corrosion and fractures, ensure the spring is good working order and not deformed or stretched.

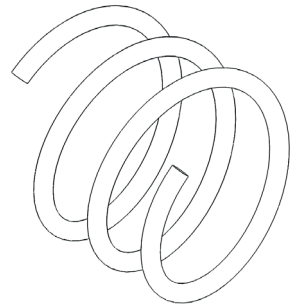

**Action: Replace if necessary.**

---

## L4.21 Lock Nut

Inspection Type: Not Applicable

Quantity: 2

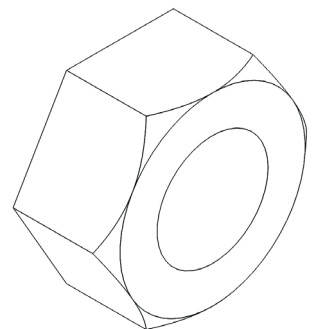

**Action: Discard and replace.**

# Maintenance and Repair

## L4.22 Handle Cover Assembly

Inspection Type: Visual

Quantity: 1

Examine lever for cracks, corrosion, distortion, damage and wear. Check selector lever function is smooth and secure. Check grip/handle is of good condition and secure. Check handle assembly fixings are of good condition.

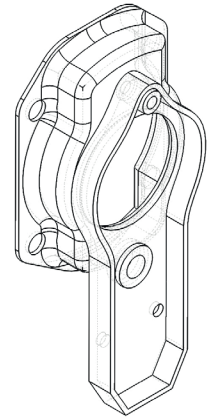

**Action: Shotblast and repaint or replace.**

## L4.23 Change Gear

Inspection Type: Visual

Quantity: 1

Check mating surface is smooth and flat, check thread, lugs and pawl drive for damage, wear and corrosion.

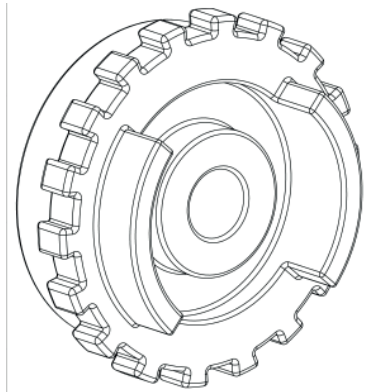

**Action: Do not shotblast - replace.**

## L4.24 Change Over Pawl

Inspection Type: Visual

Quantity: 2

Check pawl for wear ensuring pawl is free to move on pawl shaft

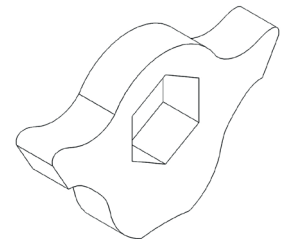

**Action: Replace if any defects found.**

## L4.25 Change Over Spring

Inspection Type: Visual

Quantity: 1

Examine spring for corrosion and fractures, ensure the spring is good working order and not deformed or stretched.

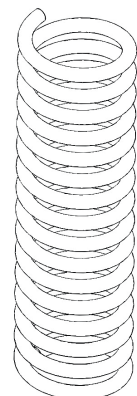

**Action: Replace if necessary.**

## Maintenance and Repair

### L4.26 Change Over Stand

Inspection Type: Visual

Quantity: 1

Check stand for wear, cracks, corrosion and damage, examine fit of pawl to selector lever shaft of handle. The pawl stand should not be bent or deformed, check spring dimensions as per diagram.

**Action: Clean, reapply grease or replace if necessary.**

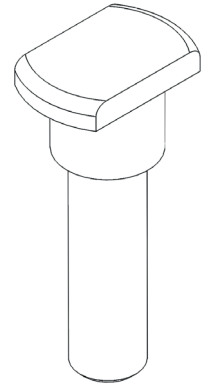

### L4.28 Lever Handle Assembly

Inspection Type: Visual

Quantity: 1

Examine lever for cracks, corrosion, distortion, damage and wear. Check selector lever function is smooth and secure. Check grip/handle is of good condition and secure. Check handle assembly fixings are of good condition.

**Action: Shotblast and repaint or replace.**

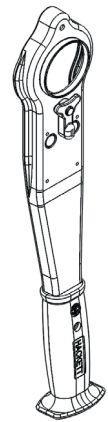

### L4.29 Screw

Inspection Type: Visual

Quantity: 1

Check thread condition.

**Action: Replace if necessary.**

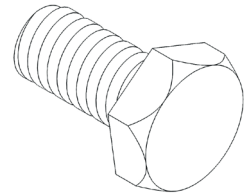

### L4.29A Spring Washer

Inspection Type: Visual

Quantity: 1

Check washer condition.

**Action: Replace if necessary.**

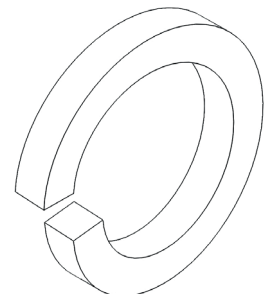

## Maintenance and Repair

### L4.30 Grip Ring

Inspection Type:

Quantity: 1

Check grip ring for wear and damage.

**Action: Shotblast and repaint or replace.**

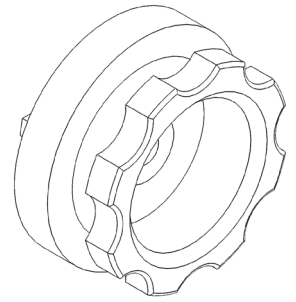

### L4.31 Stop Cam

Inspection Type: Visual

Quantity: 1

Check splines and ensure the component mating surfaces are smooth, flat and without corrosion or wear.

**Action: Replace if necessary.**

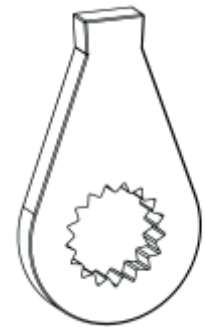

### L4.32 Washer

Inspection Type: Visual

Quantity: 1

Washer should be smooth, without damage and of good condition.

**Action: Clean, reapply grease or replace if necessary.**

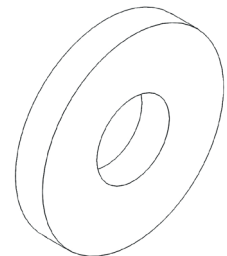

### L4.33 Castle Nut

Inspection Type: Visual

Quantity: 1

Check thread condition, check for wear or fractures.

**Action: Replace if necessary.**

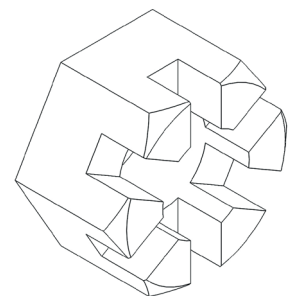

## Maintenance and Repair

### L4.34 Split Pin

Inspection Type: Not Applicable

Quantity: 1

**Action: Discard and replace.**

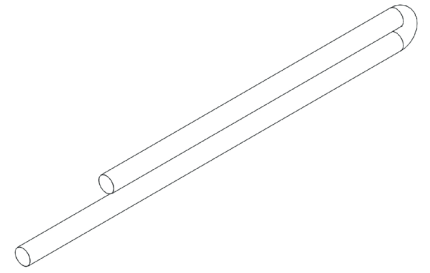

### L4.36 Square Type End Stop

Inspection Type: Visual

Quantity: 1

Check for cracks, corrosion, distortion and wear.

**Action: Replace if necessary.**

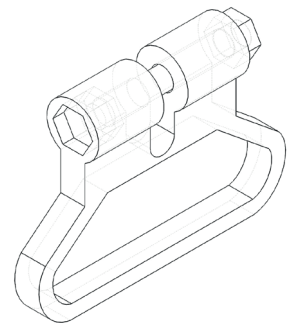

### L4.37 Bottom Hook Assembly

Inspection Type: Visual and Dimensional - contact manufacturer

Quantity: 1

Check for distortion, damage, fractures and stretching. The hook shall be free and smooth to rotate, the hook to housing contact points should have even wear, check bottom hook bolt hole to diagram.

**Action: Shotblast and repaint or replace if required.**

**For ATEX variant contact manufacturer.**

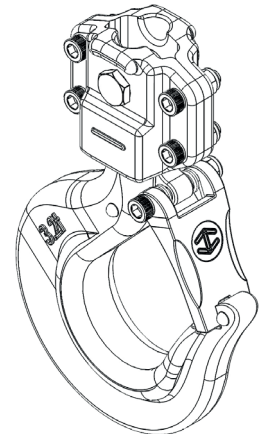

### L4.38 Chain Fixing Pin

Inspection Type: Visual

Quantity: 1

Check for damage to nut bolt and threads.

**Action: Check and replace if necessary**

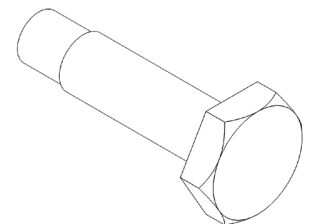



# Maintenance and Repair

## L4.47 Latch Kit

Inspection Type: Not Applicable

Quantity: 1

Latch assemblies should be secure and free/smooth to open and close. Springs and bolts should be free from cracks and damage.

**Action: Shotblast and repaint or replace.**

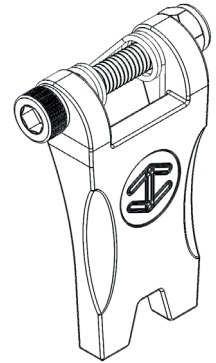

## L4.48 Label

Inspection Type: Visual

Quantity: 1

Check nameplate is secure and in good condition, the unique hoist Serial no., WLL, HOL, chain grade and dimension should all be legible.

**Action:**

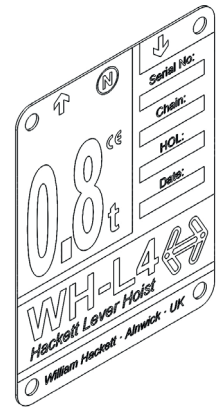

## L4.49 Label Rivets

Inspection Type: Not Applicable

Quantity: 4

**Action: Discard and replace.**

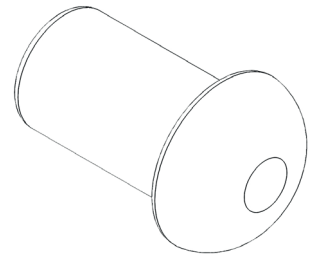

# Assembly Instructions

## Hoist Assembly

NEVER perform maintenance whilst the hoist is under load. Always use OEM parts where replacement parts are necessary.

These instructions should be used alongside the illustrated parts list.

1. Clean, lubricate and refit hoist bearings or if applicable clean and apply a light coating of grease to the plain bushes.
2. The load sheave #2 is installed into wheel side plate #1 from opposite side to the pawl shafts, the splined section shall face away from the pawl shafts.
3. Locate chain guides and chain stripper #3 and #12 ensuring they are correctly positioned.
4. Fit gear side plate #6 ensuring correct alignment with the left side plate #1, the bearing/bush securings shall be inwards towards the sheave pockets and the plate profile should mirror the opposing plate, notice the flat and curved sections of the top and bottom.
5. Grease the inner splines of the load gear #7 and locate onto the load sheave splines.
6. Apply grease to the pinion shaft where it will contact the load sheave then insert the pinion shaft with integral washer into the load sheave.
7. On 750kg and 800kg models the top hook and load pin should now be installed, the load pin is inserted from the gear side.
8. Install pinion gears ensuring correct alignment and liberally grease the complete pinion assembly.

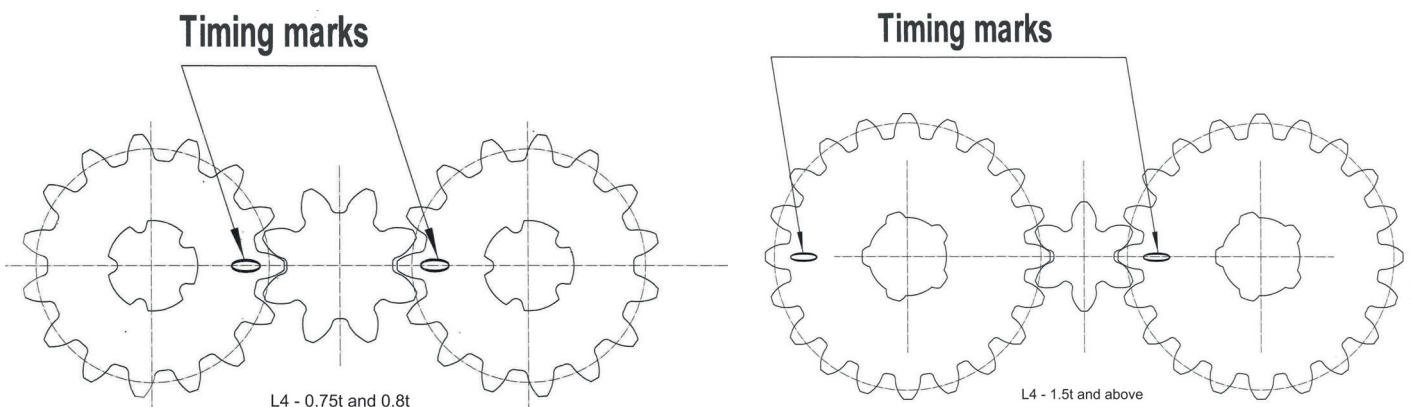

9. Fit gear cover #10 making sure the profile matches the side plate.
10. Install pawl spring #14 ensuring the spring lower is secure in the side plate.
11. Fit pawls #15 with flat side down ensuring the pawl spring upper is securely positioned over the pawl.
12. Install the circlips #15A making sure they are correctly seated in the pawl shaft recess.
13. Lightly lubricate the pinion shaft splines and threads taking care not to apply an excessive amount as this may migrate to the mating brake surfaces, locate the disc hub onto the pinion shaft splines.
14. Tension the pawl and pawl spring by rotating anti clockwise whilst installing the lower friction disc #17, make sure the ratchet disc is installed so that it correctly engages the tensioned pawls.
15. Seat springs #20 onto the disc hub #13 then fit and secure the handle cover assembly #22 using nylon locking nuts #11.

16. Install the change gear turning clockwise ensuring it is fully seated onto the upper friction disc.
17. Install the change over stand, spring and pawl #24, #25 and #26 into the upper handle and secure with fixings #21, #29 and 29A.
18. Install the stop cam #31, with the change gear fully seated the stop cam and raised limiter shall be between 15° - 20° apart (Fig. 1), now turn the change gear counter clockwise until the cam and limiter mate (Fig. 2).
19. Install the Grip Ring/Hand Wheel #30 with the slotted section over the raised tab of the change gear.
20. Replace washer #32 and castle nut #33, the nut shall be tightened finger tight then backed off to the nearest point the cotter pin can be inserted, secure cotter pin.

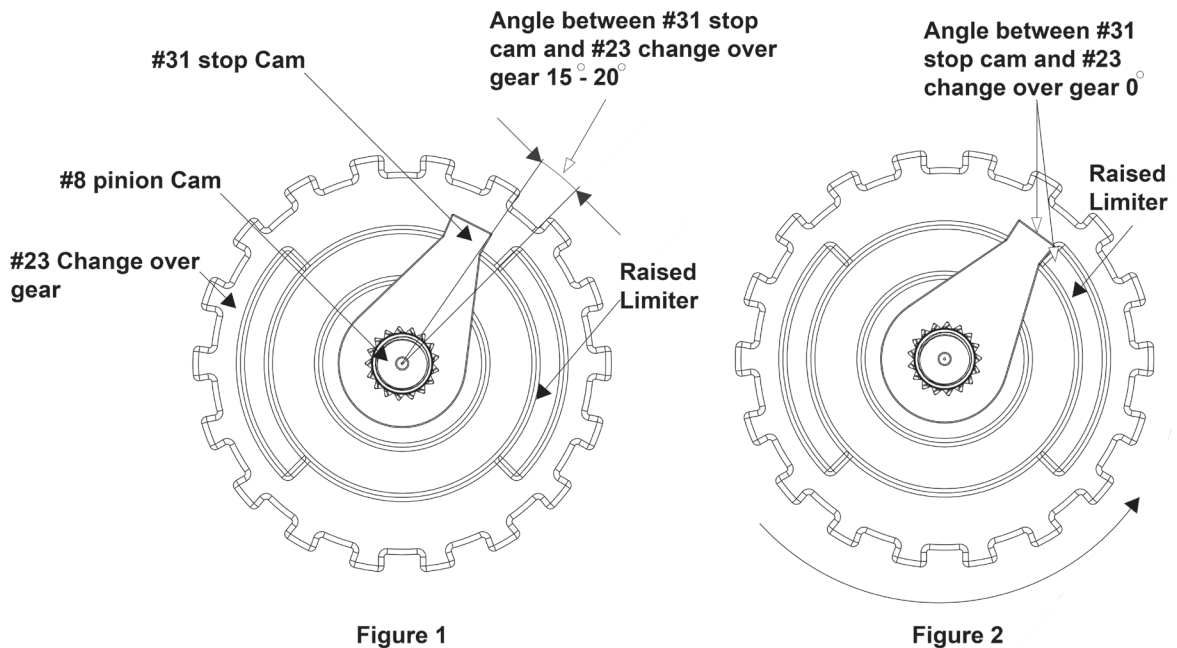

### Chain Installation

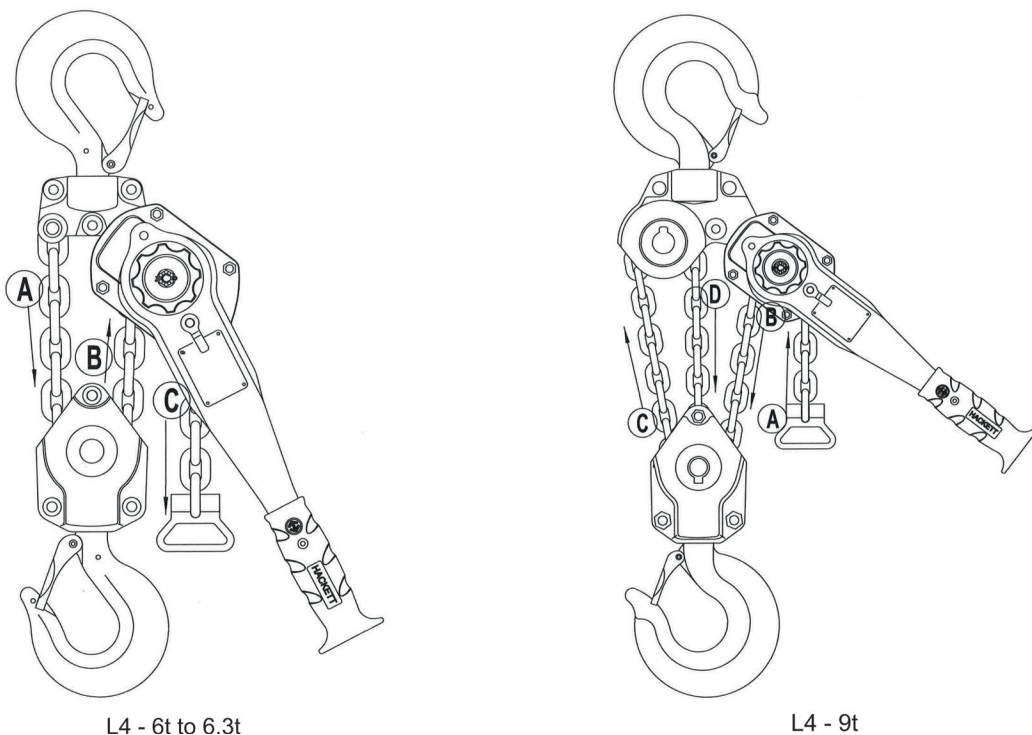

# Miscellaneous

## BRAKE DISC

### Replacement limits for brake disc

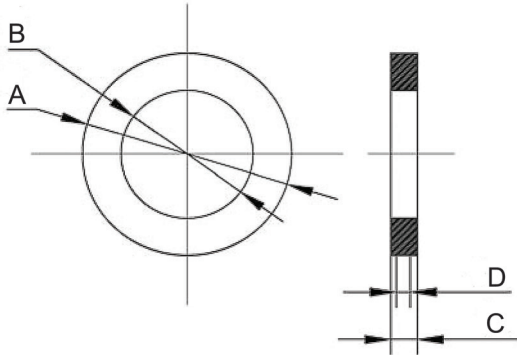

WLL kg	A mm	B mm	C mm	D mm
750/800	54	34	3.5	3
1500/1600	65	40.3	3.5	3
3000/9000	65	40.3	3.5	3

B = inner diameter    C = normal measurement  
 A = outer diameter    D = replacement limit

### Replacement limits for Pawl

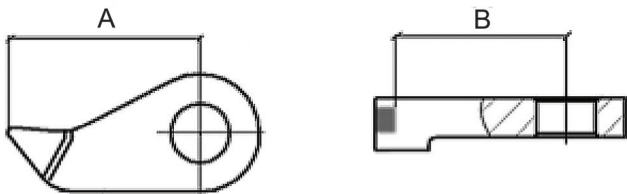

WLL kg	A mm	V min mm
750/800	22.4	20.2
1500/1600	24.4	22.3
3000/9000	27.5	24.5

### Replacement limits for Ratchet Brake System

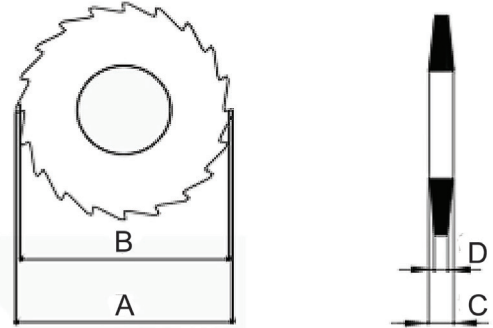

WLL kg	A mm	B min mm	C mm	D min mm
750/800	64	63	5	45
1500/1600	74	73	5	45
3000/9000	74	73	5	45

## LUBRICATION

### L4 Lever Hoist

Recommended lubricant type: Mobilgrease XHP™ 222

### L4 Lever Hoist Load Chain

Recommended Lubricant: Lear Chem ACF-50 fluid  
 or Lear Chem Corrosion Block Fluid

## TORQUE VALUE TABLE

Bolt/nut size	Min Nm	Max Nm
M5	5	6
M6	6	8
M8	20	22
M10	22	24
M12	25	27

# Warranty





When supplied new the L4 lever hoist will be supplied with a Declaration of Conformity which sanctions the use of the product for a maximum period of 12 months before re-certification is required by a competent person.

The L4 lever hoist is a lifting appliance and should be thoroughly examined by a competent person at least every 12 months, or following each period of deployment.

Only original William Hackett spare parts should be used.

William Hackett guarantee the performance of the L4 lever hoist for a period of 12 months from the date of sale subject to the purchaser and users complying with the safe use, storage, routine maintenance and servicing instructions, and there being no excessive wear and tear or misuse of the product.

These points do not affect the purchasers statutory rights.

 <b>William Hackett</b> Lifting Products Limited				  		<b>DUAL PURPOSE DOCUMENT</b>		
<b>Delivery Address</b>  ABC DISTRIBUTORS ALPHABET DRIVE ALPHABETTUS YOURCOUNTY YO13 ABC				<b>Supplied To:</b> ABC001		<b>EC DECLARATION OF CONFORMITY DECLARATION</b>		<b>A</b>
				<b>Certificate Number:</b> L029385				
				<b>Customer Order No:</b> SAMPLES		<b>MANUFACTURER'S CERTIFICATE</b>		<b>B</b>
				<b>Date Received:</b> 08/06/2017				
PRODUCTS REQUIRING A DECLARATION OF CONFORMITY ARE INDICATED BY (A) THOSE REQUIRING JUST A MANUFACTURER'S CERTIFICATE BY (B)				I DECLARE THAT THE ITEMS DESCRIBED ON THIS DOCUMENT COMPLY WITH THE REQUIREMENTS OF THE MACHINERY DIRECTIVE 2006/42/EC		CERTIFIED ON BEHALF OF THE COMPANY    T.J. BURGESS      08/06/2017		
						AUTHORIZED PERSON FOR THE CONFIGURATION OF THE DECLARATION DOCUMENTS: <b>Tim Burgess, William Hackett Lifting Products, Alnwick, UK</b>		
A/B	Batch	Lot No / Serial No	Product	Description	Qty	Working Load Limit	Proof Load	Min Breaking Load
A	P76146	60750429	HN022.053	500KG HACKETT CHAIN BLOCK 3 MTR HOL C4 to EN13157	1	500KG	750KG	
A	P77042	70220010	HN022.SS.053	500KG HACKETT SUBSEA CHAIN BLOCK 3MT HOL C4 to EN13157	1	500KG	750KG	
A	P75108	61560889	HN033.075	800KG HACKETT LEVER HOIST 1.5 MTR HOL L4 to EN13157	1	0.80 TONNE	1.2 TONNE	



**William Hackett**

e: [liftingsupplies@williamhackett.co.uk](mailto:liftingsupplies@williamhackett.co.uk)

[www.williamhackett.co.uk](http://www.williamhackett.co.uk)

**William Hackett Lifting Products Limited**

Oak Drive, Lionheart Enterprise Park

Alnwick, Northumberland

United Kingdom NE66 2EU

t: 01665 604200 f: 01665 604204

